



Wet/Dry Vacuum

## Operator's Manual



**5 Gallon**  
Model No.  
**VFB511B 0201**

### **FOR YOUR SAFETY**

Read and understand this manual before use.  
Keep this manual for future reference.



Distributed By  
Cleva North America, Inc.  
601 Regent Park Court  
Greenville, SC 29607

Replacement Filters &  
Accessories available at:  
[Vacmaster.com](http://Vacmaster.com)

# TABLE OF CONTENTS

SECTION	PAGE
Warranty .....	2
Safety Instructions & Warnings .....	3
Double Insulation Instructions .....	4
Extension Cords .....	4
Unpacking & Checking Carton Contents .....	5
General Assembly Instructions .....	6
Dry Vacuum Operation .....	7
Liquid Vacuum Operation .....	8
Blower Operation .....	9
Maintenance .....	10
Installing & Cleaning Cartridge Filter .....	11
Installing & Cleaning Foam Wet Filter .....	12
Troubleshooting .....	12
Exploded View .....	13
Parts List .....	14

**Thank you for purchasing this Vacmaster® wet/dry vacuum cleaner. Feel confident that with Vacmaster® you are obtaining a high quality product engineered for optimal performance. This vacuum is capable of picking up liquids and dry materials.**

**FOR YOUR SAFETY: CAREFULLY READ AND UNDERSTAND ALL INSTRUCTIONS.**

## WARRANTY

We take pride in producing a high quality, durable product. This Vacmaster® product carries a limited five (5) year warranty against defects in workmanship and materials from date of purchase under normal household use. If product is to be used for commercial, industrial, or rental use, a 90 day limited warranty will apply. Please keep your receipt as proof of purchase. This warranty gives you specific legal rights, and you may have other rights, which vary from state to state. For product service call Customer Service at 1-866-384-8432.

### **Not Covered by Warranty:**

- Any part that has become inoperative due to misuse, negligence, direct/indirect abuse, accidents, improper maintenance, repairs, or alterations;
- Consumables such as filters and accessories;
- Normal wear and tear of parts and attachments, such as hoses, nozzles, or casters;
- Normal deterioration of the exterior finish due to use or exposure;
- Any product where serial number/data label is tampered with or removed;
- Any product purchased from an unauthorized retailer.

# SAFETY INSTRUCTIONS & WARNINGS

## IMPORTANT SAFETY INSTRUCTIONS

### READ AND UNDERSTAND ALL INSTRUCTIONS BEFORE USING THIS VACUUM.

Read and understand this operator's manual and all labels on the Wet/Dry Vacuum cleaner before operating. Safety is a combination of common sense, staying alert, and knowing how your vacuum works. Use this Wet/Dry Vac only as described in this manual. To reduce the risk of personal injury or damage to your Wet/Dry Vac, use only Vacmaster® recommended accessories.

Household Type

## SAVE THIS MANUAL FOR FUTURE REFERENCE.

When using an electrical appliance, basic precautions should always be followed including the following:

### **WARNING:** TO REDUCE THE RISK OF FIRE, ELECTRIC SHOCK, OR INJURY:

- Do not run vacuum unattended.
- Do not vacuum, or use this Wet/Dry Vac near flammable liquids, gases, or explosive vapors like gasoline or other fuels, lighter fluids, cleaners, oil-based paints, natural gas, hydrogen, or explosive dusts like coal dust, magnesium dust, grain dust, or gun powder. Sparks inside the motor can ignite flammable vapors or dust.
- Do not vacuum anything that is burning or smoking, such as cigarettes, matches, or hot ashes.
- Keep cord away from heated surfaces.
- Do not expose to rain. Store indoors.
- Do not unplug by pulling on cord. To unplug, grasp the plug, not the cord.
- Do not use with damaged cord, plug, or other parts.
- If appliance is not working as it should, has been dropped, damaged, left outdoors, or dropped into water, return it to a service center.
- Do not pull or carry by cord, use cord as handle, close a door on cord, or pull cord around sharp edges or corners.
- Do not run Wet/Dry Vac over cord.
- Do not handle plug or the Wet/Dry Vac with wet hands.
- To reduce the risk of health hazards from vapors or dusts, do not vacuum toxic materials.
- Do not use or store near hazardous materials.
- Do not use this Wet/Dry Vac with a torn filter or without the filter installed except when vacuuming liquids as described in the operation section of this manual.
- Do not allow to be used as a toy. Close attention is necessary when used by or near children.
- To reduce the risk of injury from accidental starting, unplug power cord before changing or cleaning filter.
- Do not leave Wet/Dry Vac unattended when plugged in. Unplug when not in use and before servicing.
- Turn off Wet/Dry Vac before unplugging.
- Do not put any object into ventilation openings. Do not vacuum with any ventilation openings blocked; keep free of dust, lint, hair, or anything that may reduce air flow.
- Keep hair, loose clothing, fingers, and all parts of body away from openings and moving parts.
- To reduce the risk of falls, use extra care when cleaning on stairs.
- Unplug before connecting hose.
- Use only as described in this manual. Use only manufacturer's recommended attachments.
- This appliance is provided with double insulation. Use only identical replacement parts. See "DOUBLE INSULATION INSTRUCTIONS".

### When using as blower:

- Direct air discharge only at work area.
- Do not use Wet/Dry Vac as a sprayer.
- Do not direct air at bystanders.
- Keep children away when blowing.
- Use safety goggles.

# DOUBLE INSULATION INSTRUCTIONS

This Wet/Dry Vac is double-insulated, eliminating the need for a separate grounding system. Use only identical replacement parts. Read the instructions for servicing Double-Insulated Wet/Dry Vacs before servicing. Use this Wet/Dry Vac as described in this manual. Observe the following warnings that appear on the motor housing of your Wet/Dry Vac.



**DOUBLE INSULATED - GROUNDING NOT REQUIRED - WHEN SERVICING USE ONLY IDENTICAL REPLACEMENT PARTS.**

**WARNING: TO REDUCE THE RISK OF ELECTRIC SHOCK, DO NOT EXPOSE TO RAIN. STORE INDOORS.**

**CAUTION:** Do not vacuum drywall dust, fireplace soot, or ash with a standard Wet/Dry filter. This is a very fine dust which will not be captured by the filter and may cause damage to the motor. When vacuuming fine dust, use a fine dust filter (included). To purchase the additional fine dust filters, call 1-866-384-8432 or get them at your local or online Vacmaster® retailer.

**WARNING: SERVICING OF DOUBLE-INSULATED WET/DRY VACUUM WITH A DOUBLE-INSULATED WET/DRY VACUUM, TWO SYSTEMS OF INSULATION ARE PROVIDED INSTEAD OF GROUNDING. NO GROUNDING MEANS IS PROVIDED ON A DOUBLE-INSULATED APPLIANCE, NOR SHOULD A MEANS FOR GROUNDING BE ADDED. SERVICING A DOUBLE INSULATED WET/DRY VACUUM REQUIRES EXTREME CARE AND KNOWLEDGE OF THE SYSTEM, AND SHOULD BE DONE ONLY BY QUALIFIED SERVICE PERSONNEL. REPLACEMENT PARTS FOR A DOUBLE-INSULATED WET/DRY VACUUM MUST BE IDENTICAL TO THE PARTS THEY REPLACE. YOUR DOUBLE-INSULATED WET/DRY VAC IS MARKED WITH THE WORDS 'DOUBLE INSULATED' AND THE SYMBOL  (SQUARE WITHIN A SQUARE) MAY ALSO BE MARKED ON THE APPLIANCE.**

- To reduce the risk of electric shock, unplug before cleaning or servicing.
- DO NOT use without filters in place.

**CAUTION:** To reduce the risk of injury from moving parts, unplug before servicing.

# EXTENSION CORDS

When using an extension cord with your Wet/Dry Vac refer to the following table to determine the required A.W.G. wire size. Before using the cleaner make sure the power cord and extension cord are in good working condition. Make repairs or replacements before using the vacuum cleaner. Only use extension cords that are rated for outdoor use.

110V-120V	Length of Extension Cord			
	25 Feet 7.5 Meters	50 Feet 15.25 Meters	100 Feet 30.5 Meters	150 Feet 45.7 Meters
Amps	A.W.G. Wire Size			
0-6	18	16	16	14
7-10	18	16	14	12
11-12	16	16	14	12
13-16	14	12	Not recommended	

# UNPACKING & CHECKING CARTON CONTENTS

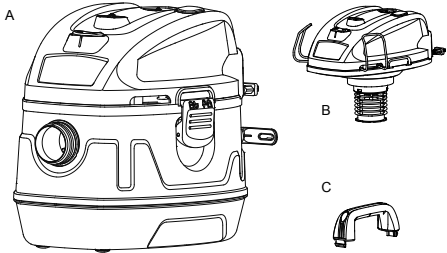

Remove all contents from the box. Remove the power head and take out any contents inside the collection tank. Check each item against the carton contents list.

## Carton Contents List:

Key	Description	Qty.
A	Vac Assembly	1
B	Filter Basket	1
C	Handle Assembly	1
D	Extension Wands	2
E	Foam Wet Filter	1
F	Crevice Tool	1
G	Car Nozzle	1
H	Utility Nozzle	1
I	Cartridge Filter	1
J	EVA Hose	1
K	Noise Diffuser	1
L	2 Screws (Bag)	1
M	Hose Storage Rack	2
N	Manual	1

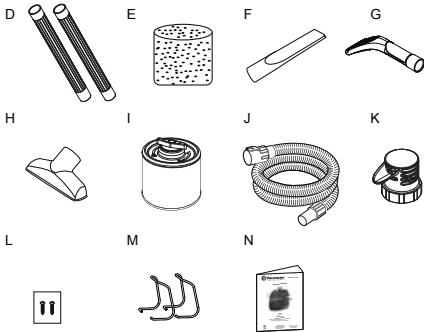

**NOTE:** The hose and accessories for this vacuum are 1-7/8" diameter.

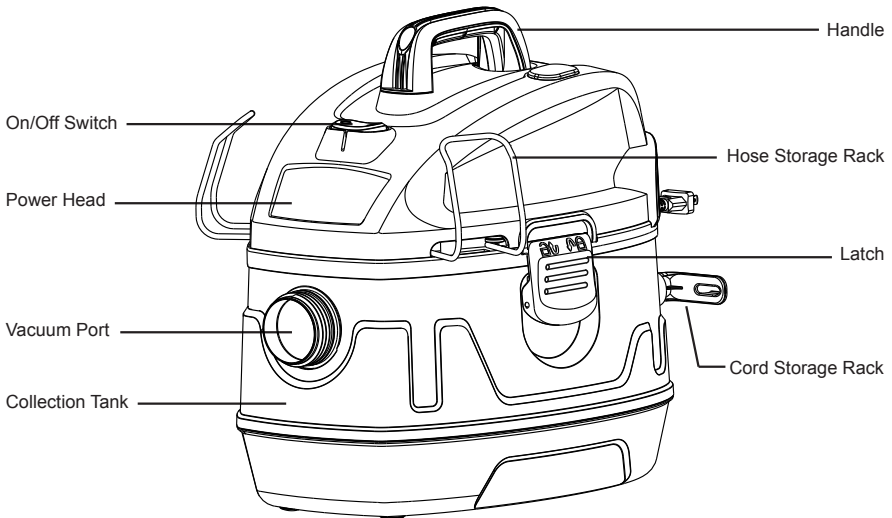

# GENERAL ASSEMBLY INSTRUCTIONS

A Phillips head screw driver is required.

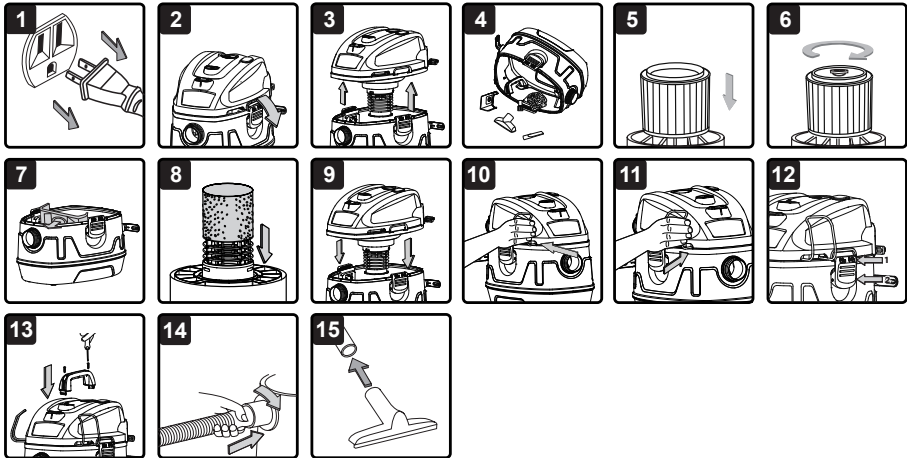

## UNPACKING YOUR WET/DRY VACUUM & GENERAL ASSEMBLY

1. Verify that the power cord is disconnected from the outlet. (Fig. 1)
2. Undo the latches. (Fig. 2)
3. Lift the power head off the collection tank. (Fig. 3)
4. Remove the contents from inside the collection tank; make sure you have all contents as listed on page 5. (Fig. 4)
5. Your vacuum comes ready for dry vacuum cleaning. For installation instructions, see page 11. (Fig. 5 & 6)
6. Optional: For improved dust filtering, fit collection bag flange onto the inlet port, taking care not to damage the bag. Dust bag sold separately. (Fig. 7)
7. For wet vacuum cleaning, install the supplied foam wet filter. (Fig. 8) See page 12 for filter installation.
8. Place the power head back on the tank. (Fig. 9)
9. Position the hose storage rack as illustrated. Insert one side of the rack into the channel making sure it is secured in place. Squeeze in the other end and insert it into the corresponding channel making sure it is secured. (Fig. 10 & 11)
10. Place the power head back on the tank, aligning the top section with the latches, and snap into place. (Fig. 12)
11. Insert the handle into the slots located on the top of the power head and secure it with the screws provided. Do not over-tighten the screws. (Fig. 13)
12. Insert the locking end of the hose into the vacuum port and turn to lock into place. (Fig. 14)
13. Choose the desired accessories and extension wands and push onto the hose. (Fig. 15)

## NOISE DIFFUSER

For quiet operation, install the noise diffuser into the blower port by inserting the locking end of the diffuser into the blower port and turning clockwise to lock into place.

## POLARIZED PLUG

To reduce the risk of electrical shock, this appliance has a polarized plug (one blade wider than the other). This plug will fit in a polarized outlet only one way. If the plug does not fit fully in the outlet, reverse the plug. If it still does not fit, contact a qualified electrician to install the proper outlet. Do not change the plug in any way. Double insulation  eliminates the need for the three wire grounded power cord and grounded power supply system.

# DRY VACUUM OPERATION

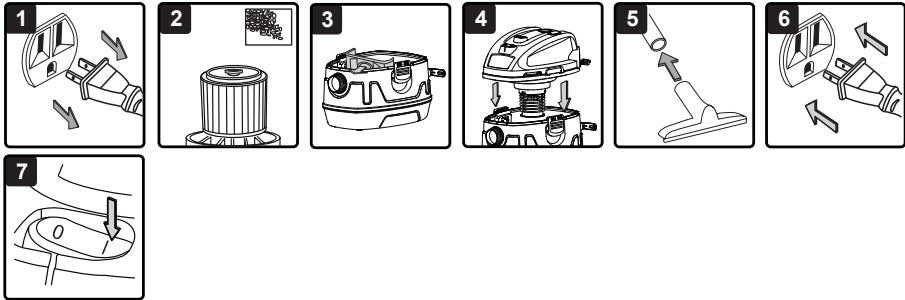

## DRY VACUUMING

**WARNING: BE SURE TO READ, UNDERSTAND, AND APPLY, INFORMATION ENTITLED 'SAFETY INSTRUCTIONS & WARNINGS'. DO NOT VACUUM IN AREAS WITH FLAMMABLE GASES, VAPORS, OR EXPLOSIVE DUSTS IN THE AIR. FLAMMABLE GASES OR VAPORS INCLUDE BUT ARE NOT LIMITED TO: LIGHTER FLUID, SOLVENT TYPE CLEANERS, OIL-BASED PAINTS, GASOLINE, ALCOHOL, OR AEROSOL SPRAYS. EXPLOSIVE DUSTS INCLUDE BUT ARE NOT LIMITED TO: COAL, MAGNESIUM, GRAIN, OR GUN POWDER. TO REDUCE THE RISK OF HEALTH HAZARDS FROM VAPORS OR DUST, DO NOT VACUUM TOXIC MATERIALS.**

## NOTICE

Do not vacuum drywall dust, fireplace soot, or ash with a standard Wet/Dry filter. This is a very fine dust which will not be captured by the filter and may cause damage to the motor. When vacuuming fine dust, use a fine dust filter (included). To purchase the additional fine dust filters, call 1-866-384-8432 or get them at your local or online Vacmaster® retailer.

**WARNING: DO NOT PLUG POWER CORD INTO POWER OUTLET. MAKE SURE PLUG IS DISCONNECTED BEFORE CHANGING THE FILTERS.**

1. Verify that the power cord is disconnected from the outlet. (Fig. 1)
2. In order to prepare your vacuum for dry vacuuming, verify that the cartridge filter is securely mounted. Make sure the filter is pushed in until it stops against the power head. Your Wet/Dry Vac comes with the cartridge filter pre-installed. For installation instructions, see page 11. (Fig. 2)
3. Optional: For improved dust filtering, fit collection bag flange onto the inlet port, taking care not to damage the bag. Dust bag sold separately. (Fig. 3)
4. Place the power head back on the collection tank, aligning the top section with the latches, and snap into place. (Fig. 4)

## OPERATING INSTRUCTIONS: DRY VACUUMING

5. Insert the locking end of the hose into the vacuum port and lock in place. Push the required attachment onto the free end of the hose or extension. (Fig. 5)
6. Plug the power cord into the outlet. (Fig. 6)
7. Turn the motor on by flipping the switch to the 'I' ON position. (Fig. 7)
8. Once you have completed vacuuming, flip the switch to the 'O' OFF position and unplug the power cord from the outlet.

O = OFF      I = ON

**DO NOT USE THE CARTRIDGE FILTER FOR LIQUID VACUUMING.  
DO NOT USE DUST BAG FOR LIQUID VACUUMING.**

# LIQUID VACUUM OPERATION

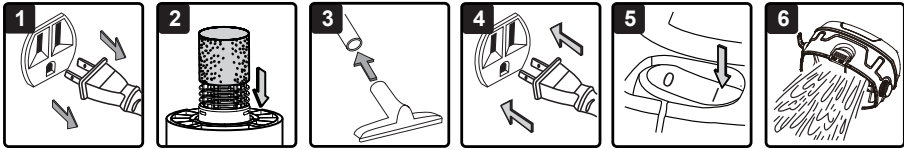

## LIQUID VACUUMING

**WARNING: BE SURE TO READ, UNDERSTAND, AND APPLY, INFORMATION ENTITLED 'SAFETY INSTRUCTIONS & WARNINGS'. DO NOT VACUUM IN AREAS WITH FLAMMABLE GASES, VAPORS, OR EXPLOSIVE DUSTS IN THE AIR. FLAMMABLE GASES OR VAPORS INCLUDE BUT ARE NOT LIMITED TO: LIGHTER FLUID, SOLVENT TYPE CLEANERS, OIL-BASED PAINTS, GASOLINE, ALCOHOL, OR AEROSOL SPRAYS. EXPLOSIVE DUSTS INCLUDE BUT ARE NOT LIMITED TO: COAL, MAGNESIUM, GRAIN, OR GUN POWDER. TO REDUCE THE RISK OF HEALTH HAZARDS FROM VAPORS OR DUST, DO NOT VACUUM TOXIC MATERIALS.**

**WARNING: DO NOT PLUG POWER CORD INTO POWER OUTLET. MAKE SURE PLUG IS DISCONNECTED BEFORE CHANGING THE FILTERS.**

1. Verify that the power cord is disconnected from the outlet. (Fig. 1) Make sure that the collection tank is clean and free from dust and dirt.
2. Remove cartridge filter and collection bag, then carefully install the foam wet filter over the filter cage and place the power head back on the collection tank. (Fig. 2) For filter installation instructions, see page 12.
3. Fit the desired nozzle to the vacuum hose. (Fig. 3)

### OPERATING INSTRUCTIONS: WET VACUUMING

4. Verify that the switch is in the 'O' OFF position before plugging the power cord into the outlet. (Fig. 4)
5. Turn the motor on by flipping the switch to the 'I' ON position. (Fig. 5)
6. After use, flip the switch to the 'O' OFF position and unplug the power cord from the outlet. Empty the collection tank into a suitable receptacle or drain. (Fig. 6)

**IMPORTANT!** When vacuuming large quantities of liquids, do not immerse the nozzle completely in the liquid; leave a gap at the tip of the nozzle opening to allow air inflow. The machine is fitted with a float valve that stops the suction action when the collection tank reaches its maximum capacity. You will notice an increase in motor speed. When this happens, turn off the machine, disconnect from power supply, and drain the liquid into a suitable receptacle or drain. To continue vacuuming, refit the power head to the collection tank. After wet vacuuming, turn the machine off and remove plug from power supply. Empty the collection tank, clean and dry the inside and outside before storage. **REMEMBER!** The foam filter must be removed after wet vacuuming, and a cartridge filter must be installed before dry vacuuming again.

**DO NOT USE THE CARTRIDGE FILTER FOR LIQUID VACUUMING.  
DO NOT USE COLLECTION BAG FOR LIQUID VACUUMING.**



# BLOWER OPERATION

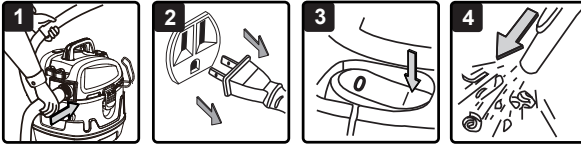

This Wet/Dry Vac has blowing capabilities. To use the blower feature follow the instructions listed.

**WARNING: ALWAYS WEAR SAFETY GOGGLES COMPLYING WITH ANSI Z87.1 (OR IN CANADA, CSAZ94.3) BEFORE USING BLOWER.**

**WARNING: KEEP BYSTANDERS CLEAR FROM BLOWING DEBRIS.**

**WARNING: WEAR A DUST MASK IF BLOWING CREATES DUST THAT MIGHT BE INHALED.**

1. Verify that the power cord is disconnected from the outlet. (Fig. 1)
2. Make sure the collection tank is empty before using as a blower.
3. Remove hose from the vacuum port. Remove noise diffuser from blower port.
4. Insert the large end of the hose into the blower port on the back side of the power head and screw into position. (Fig. 2)
5. Fit the desired extension wand and / or nozzle to the vacuum hose.
6. Verify that the switch is in the 'O' OFF position before plugging the power cord into the outlet.
7. Before turning on the vac, firmly hold loose end of the hose. Turn the motor on by flipping the switch to the 'I' ON position. (Fig. 3)
8. The unit will now blow through the vacuum hose and can be used to clear obstructions within the hose. (Fig. 4)
9. Once you have completed vacuuming, flip the power switch to the 'O' (OFF) position and unplug the power cord from the outlet.

# MAINTENANCE

## Emptying the Collection Tank

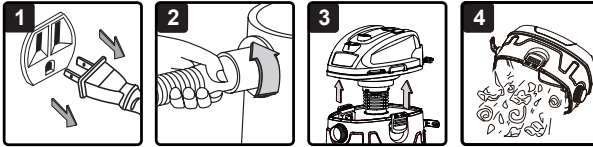

**WARNING: MAKE SURE POWER CORD IS DISCONNECTED BEFORE CHANGING THE FILTERS.**

1. Verify that the power cord is disconnected from the outlet. (Fig. 1)
2. Disconnect the hose from the vacuum by turning in a counter clockwise direction. (Fig. 2)
3. Undo the latches and remove the power head from the collection tank. (Fig. 3)
4. Clear all dirt or debris from the collection tank and hose. (Fig. 4)
5. Clean or replace the filters.
6. Check the hose, attachments, and power cord to verify that they have not been damaged.
7. Place power head back onto collection tank and secure latches.

**IMPORTANT!** Clean or change the cartridge filter regularly for best performance.

**ALWAYS USE CARTRIDGE FILTER FOR DRY VACUUMING.** If the machine is used without the cartridge filter, the motor will burn out and the warranty will be voided. Always keep spare filters on hand.

**NOTICE!** The filters included are made of high quality materials designed to stop small dust particles. The cartridge filter should be used for dry pick-up only. A dry cartridge filter is necessary to pick up dust. If the cartridge filter is wet, it will clog quickly and be very difficult to clean. Handle the filter carefully when removing it for cleaning and replacing it. Check the filters for tears small holes, a small hole can let dust pass through and out of the filter. Do not use a filter with holes or tears; replace it immediately.

**WARNING: ALWAYS DISCONNECT THE PLUG FROM THE POWER OUTLET BEFORE REMOVING THE POWER HEAD FROM COLLECTION TANK.**

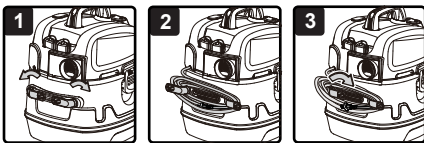

## Cord Storage

1. When unpacking your new Wet/Dry Vacuum, the cord storage hooks will be turned inward.
2. To use the cord storage, rotate both hooks outward until they click into place. (Fig. 1 & 2)
3. When you are ready to use your vacuum, simply rotate one of the hooks inward to quickly release the cord. (Fig. 3)

## Storage

Before storing your vacuum cleaner, the collection tank should be emptied and cleaned. The hose should be wrapped with the storage racks. The accessories should be stored so they can be readily available when needed. Store vacuum cleaner indoors.

# INSTALLING & CLEANING CARTRIDGE FILTER

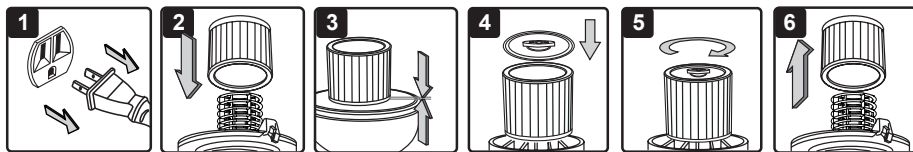

## Installing Cartridge Filter

1. Verify that the power cord is disconnected from the outlet. (Fig. 1)
2. Remove power head and place in upside down position.
3. Install the cartridge filter over the filter cage with the flat end of the filter towards the power head. Carefully push filter in until it stops against the power head. (Fig. 2 & 3)
4. Place filter retainer on top of cartridge filter over the raised lip and tighten down by turning retainer clockwise, do not over-tighten. (Fig. 4 & 5)

## Removing and Cleaning Cartridge Filter

1. Unlock and remove the filter retainer by turning retainer handle counter clockwise.
2. Carefully hold and pull the cartridge filter up for removal. (Fig. 6)
3. Clean the cartridge filter by gently tapping or brushing dirt off. Cleaning should not be done indoors in living areas. For optimal performance a new filter is recommended.
4. Install cleaned or new filter as instructed above in steps 2 and 3 of Installing Cartridge Filter.
5. Wet filters should be removed and allowed to air dry for 24 hours before installing onto the filter cage.

**IMPORTANT!** Clean or change the cartridge filter regularly for best performance.

**ALWAYS USE CARTRIDGE FILTER FOR DRY VACUUMING.** If the machine is used without the cartridge filter, the motor will burn out and the warranty will be voided. Always keep spare filters on hand.

**WARNING: ALWAYS DISCONNECT THE PLUG FROM THE POWER OUTLET BEFORE REMOVING THE POWER HEAD FROM THE COLLECTION TANK.**

# INSTALLING & CLEANING FOAM WET FILTER

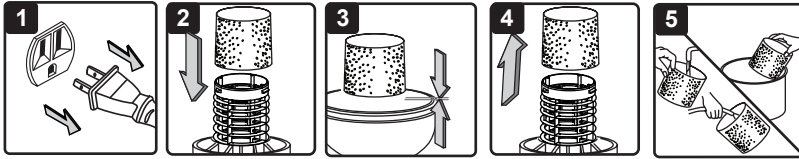

## Installing Foam Wet Filter

1. Verify that the power cord is disconnected from the outlet. (Fig.1)
2. Remove power head and place in upside down position. Follow instructions to remove cartridge filter.
3. Carefully slide foam wet filter down over the filter cage making sure the cage is completely covered. (Fig. 2 & 3)
4. Place the power head onto the collection tank.

## Cleaning Foam Wet Filter

1. With the removed power head in an upside down position, carefully remove foam wet filter. (Fig. 4)
2. Use a mild soap and water solution to wash foam wet filter and rinse with clean water. (Fig. 5)
3. Allow filter to air dry before installing and using again.

# TROUBLESHOOTING

**WARNING: TO REDUCE THE RISK OF ELECTRIC SHOCK, UNPLUG BEFORE TROUBLESHOOTING.**

Symptom	Possible Causes	Corrective Action
Vacuum will not operate	1) No power supply.	1) Check power supply – cord, breakers, fuses.
	2) Faulty power cord.	2) Unplug and check the power cord. If damaged, have it repaired by a professional.
	3) Collection tank full.	3) Empty collection tank.
Dust comes out from motor cover.	1) The cartridge filter is missing or damaged.	1) Attach or replace cartridge filter.
Reduced efficiency and motor/ speed vibration.	1) There is a blockage in the nozzle, hose, or the collection tank inlet. The cartridge filter is clogged by fine dust.	1) Check nozzle, hose and collection tank inlets for blockage. Take off the filter and clean it or install a new cartridge filter.

# EXPLODED VIEW

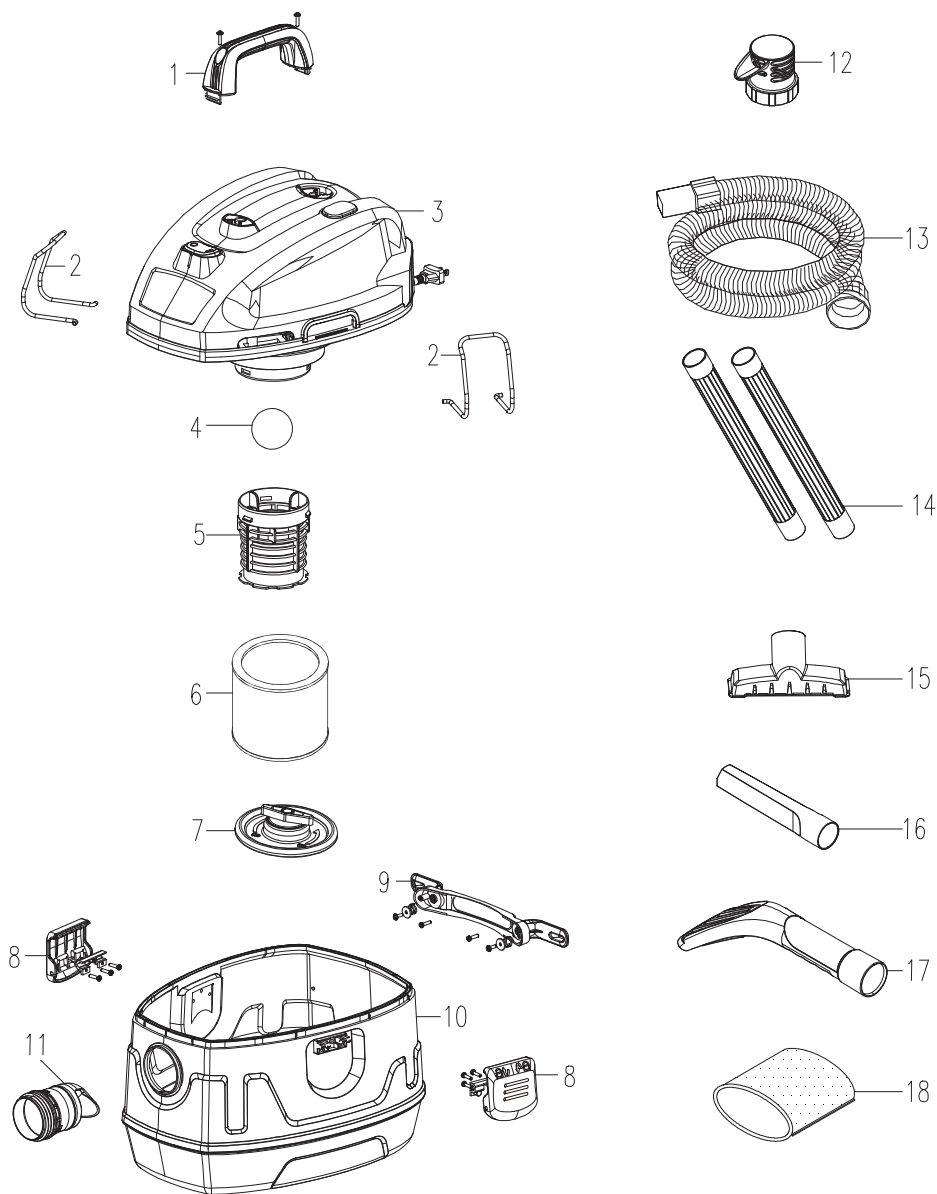

# PARTS LIST

Part	Drawing Number	Description	Quantity
1	551253101	Handle Assembly	1
2	551013103	Hose Holder	2
3		Power Head Assembly	1
4	551013104	Float	1
5	551012116	Filter Cage	1
6	V# F	Cartridge Filter	1
7	551062108	Filter Retainer	1
8	551253104	Latch Assembly	2
9	551062104	Quick Release Cord Wrap Assembly	1
10		Collection Tank	1
11	551062105	Vacuum Port Assembly	1
12	551027140	Noise Diffuser	1
13	551059111	EVA Hose	1
14	551001121	Extension Wands	2
15	551011109	Utility Nozzle	1
16	551109125	Crevice Tool	1
17	551109126	Car Nozzle	1
18	VFF21	Foam Wet Filter	1